

Enhancement of Mass Transfer of Ozone by Gas- and Liquid-Phase Flow Induced by Corona Discharge above Water

Summary

A corona discharge was generated above a water surface with a needle–water electrode configuration. Circulating flow generation in gas and liquid phases were observed by a numerical simulation and experiments. Methylene blue (MB) in water was decomposed by ozone supplied to the gas phase. The corona discharge-induced flow enhanced the mass transfer of ozone through the water surface, resulting in higher decomposition rate of methylene blue than that without the corona discharge.

Flow Generation under Two Configurations

(a) With corona discharge

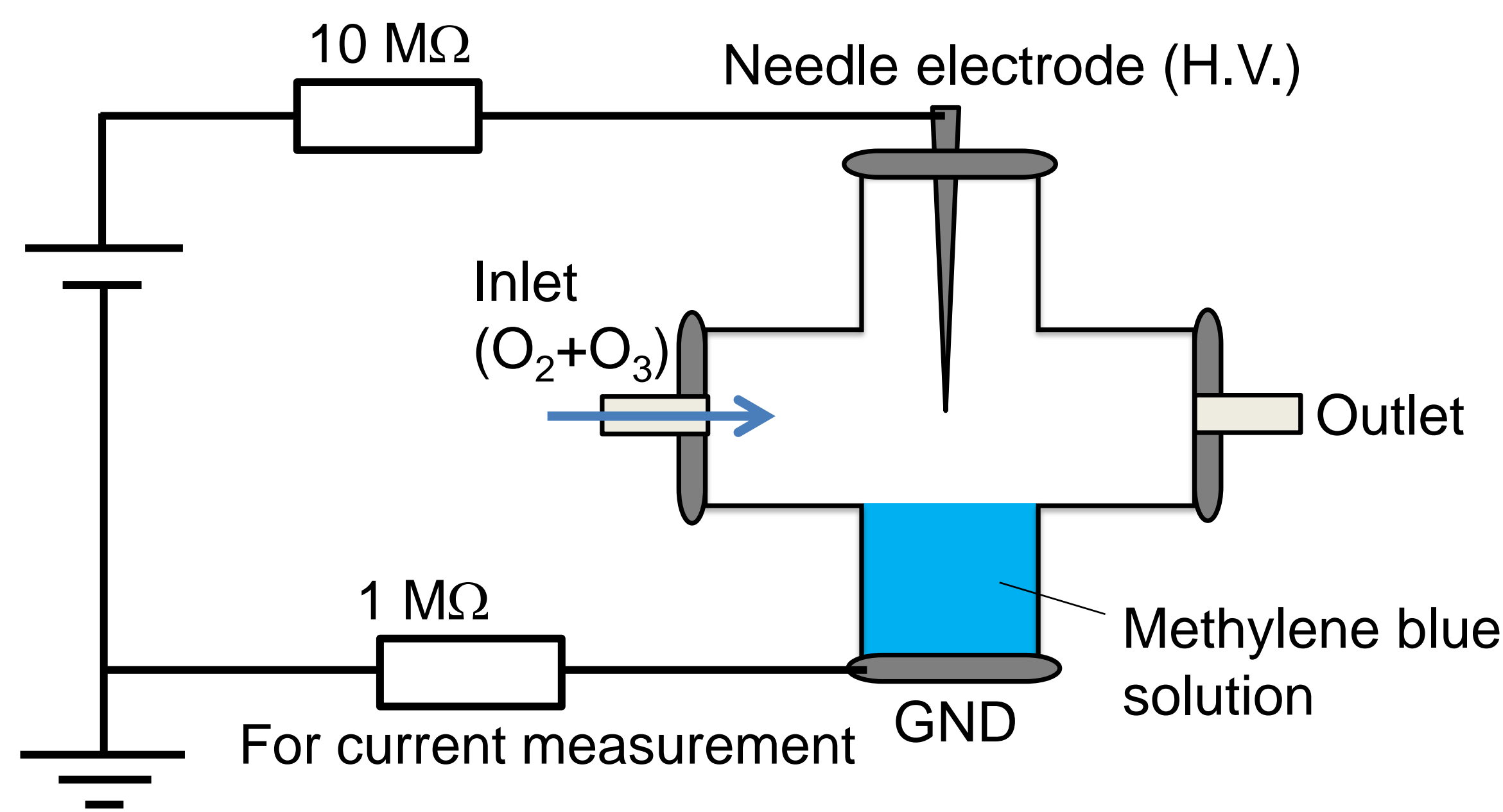

Experimental condition

Gap distance [mm]	3 ~ 21.5
Applied voltage [kV]	0 ~ 25
Gas flow rate [sccm]	1,000
Ozone concentration [g/m ³]	31.4
Solution volume [mL]	20
MB concentration [mg/L]	8.9

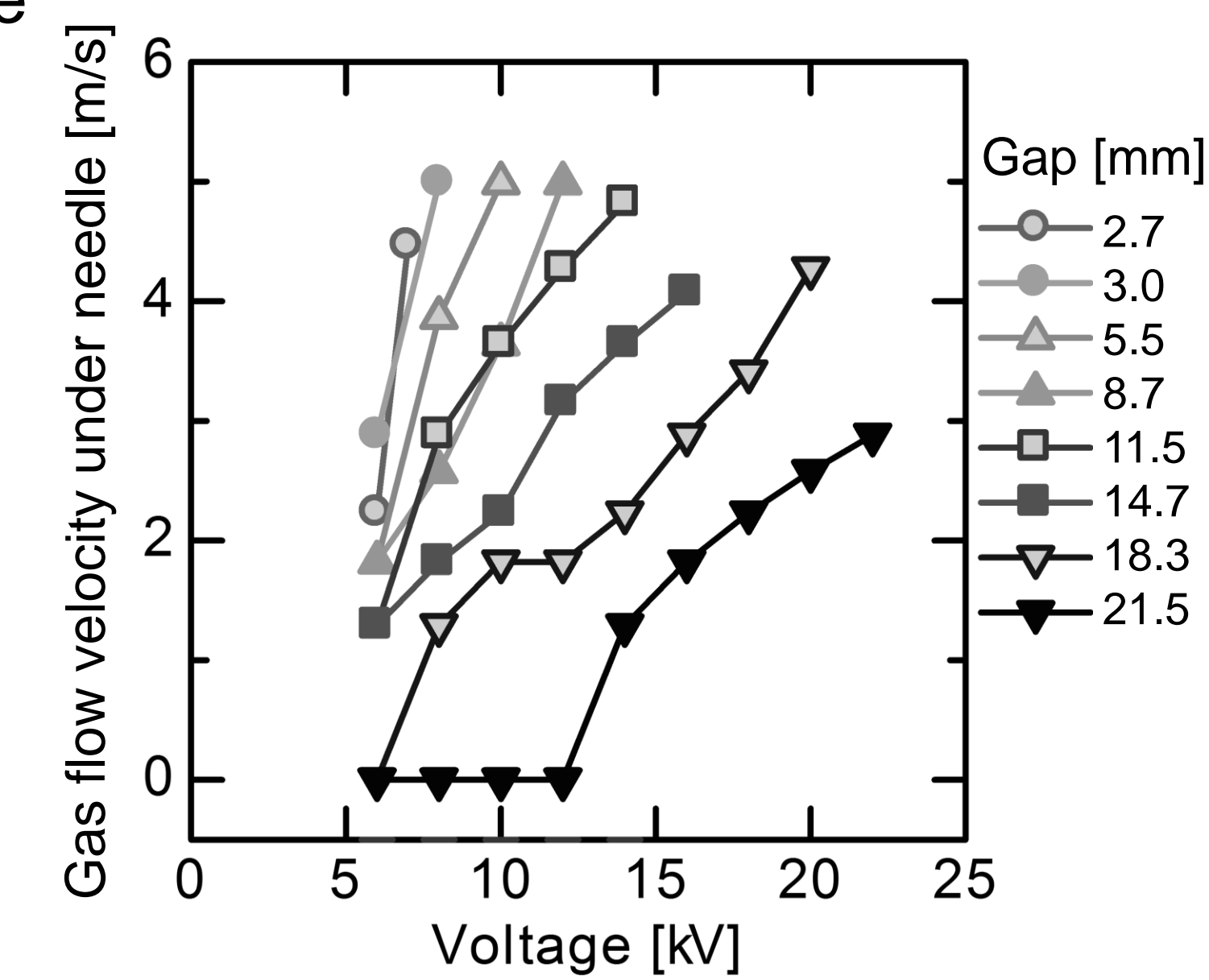
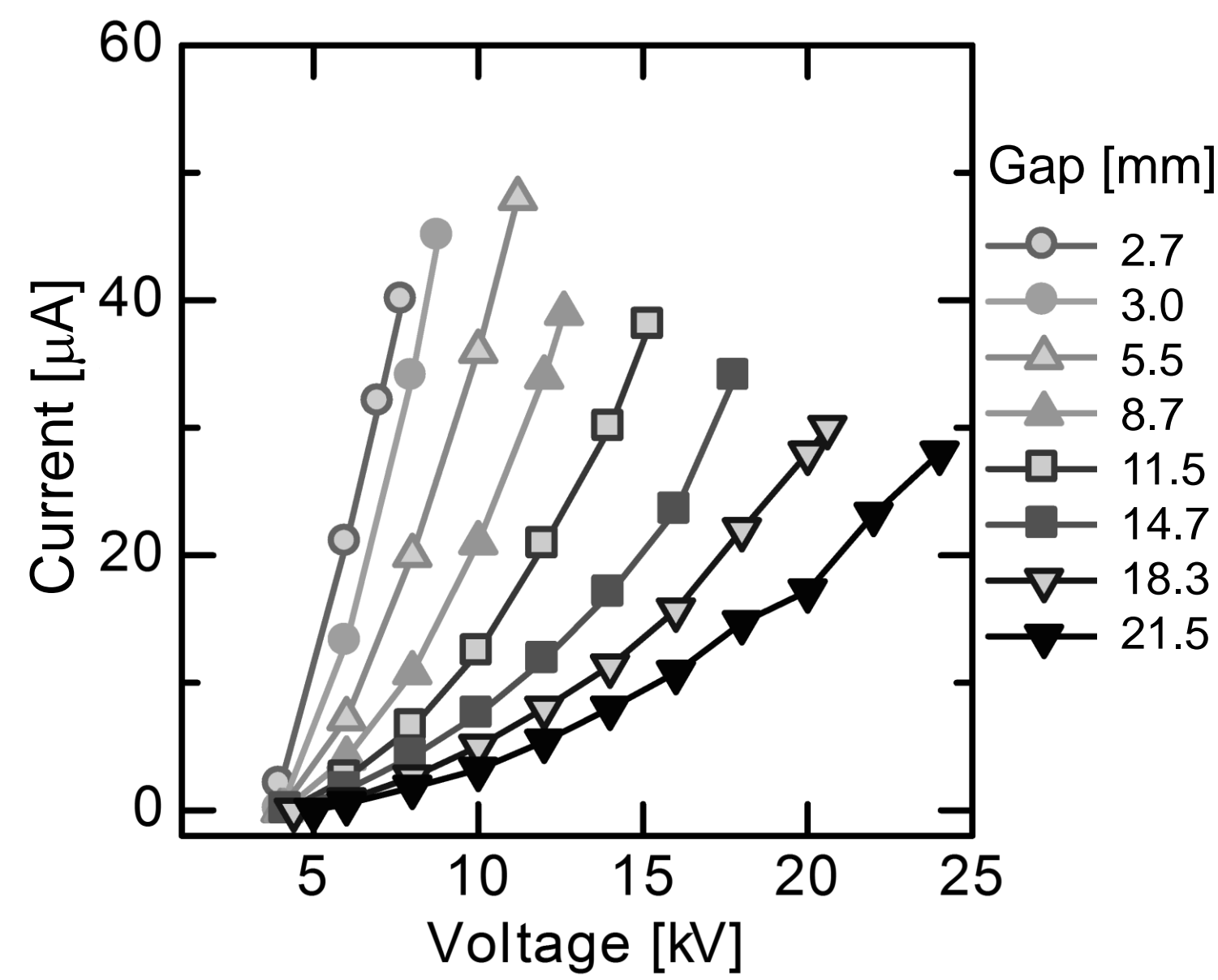

*Gas flow velocity was estimated from the deformation depth of water surface.

(b) With gas injection

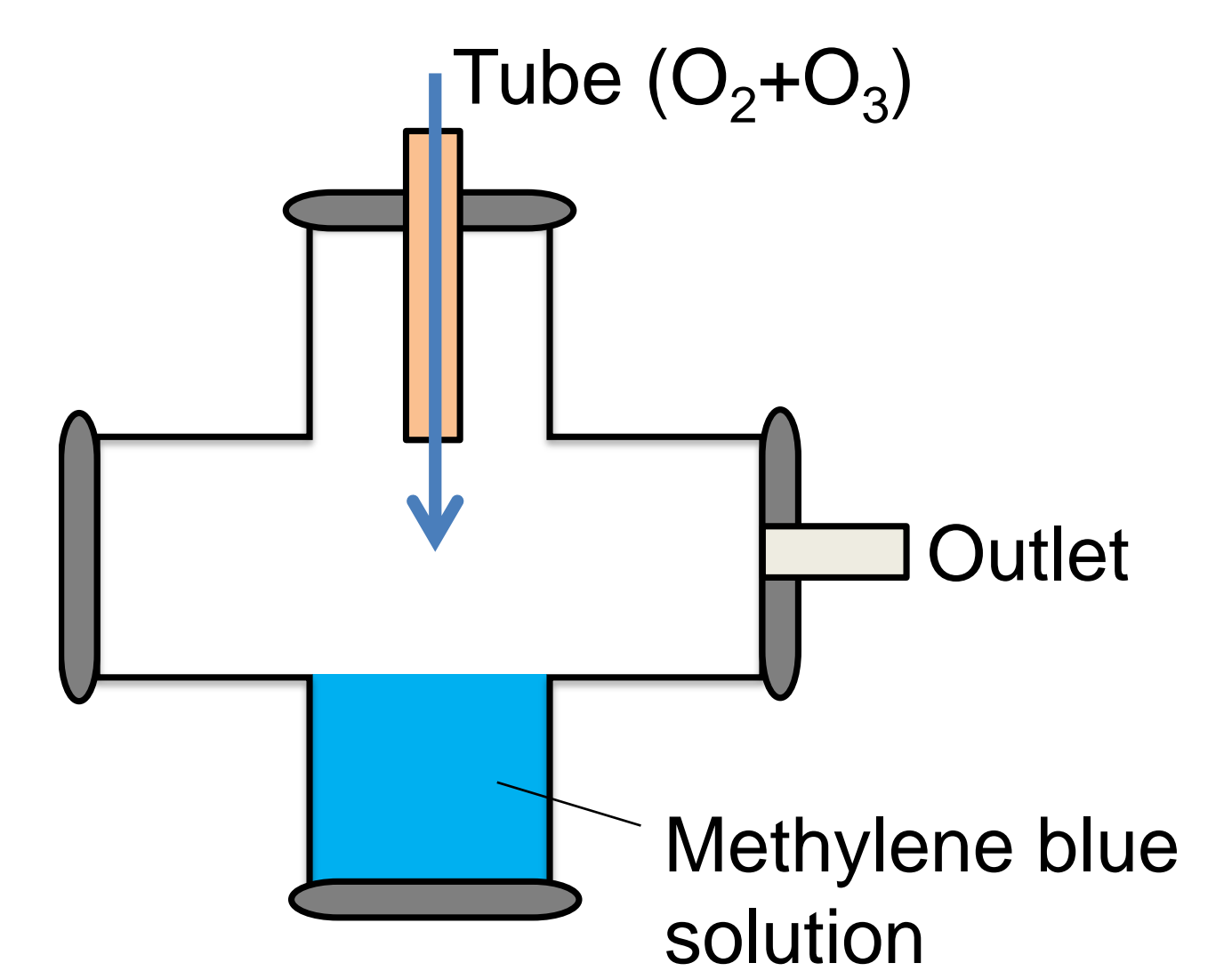

Experimental condition

Gap distance [mm]	3 ~ 15
Gas flow rate [sccm]	0 ~ 1,000
Ozone concentration [g/m ³]	31.4
Solution volume [mL]	20
MB concentration [mg/L]	8.9

Appearance of water surface with corona

Needle electrode

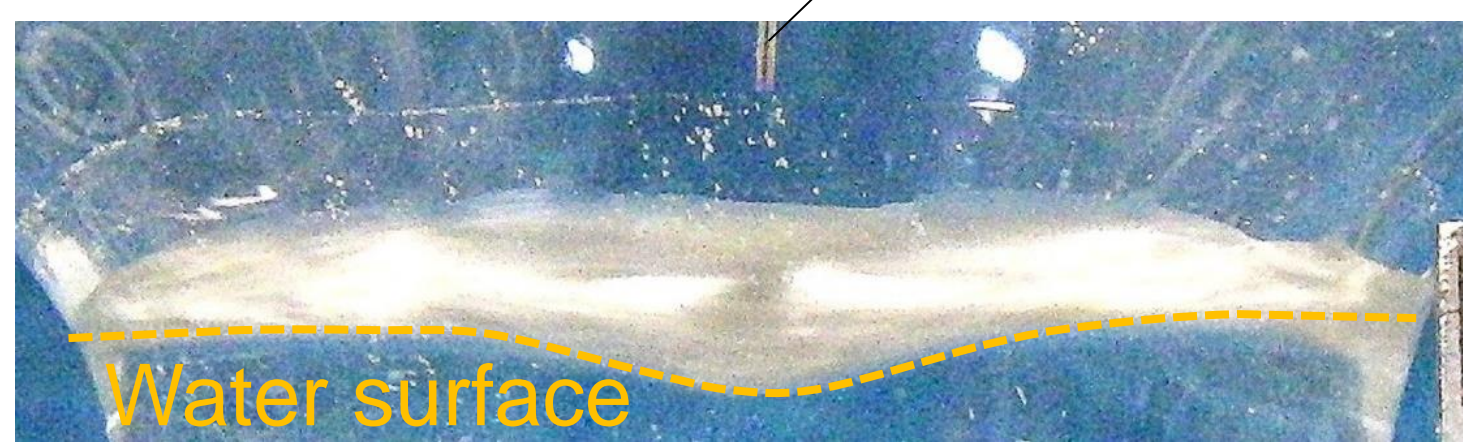

- Deformation of water surface was observed with ionic flow generation in gas phase.
- Fluctuation of water surface occurred with corona discharge.

Tube

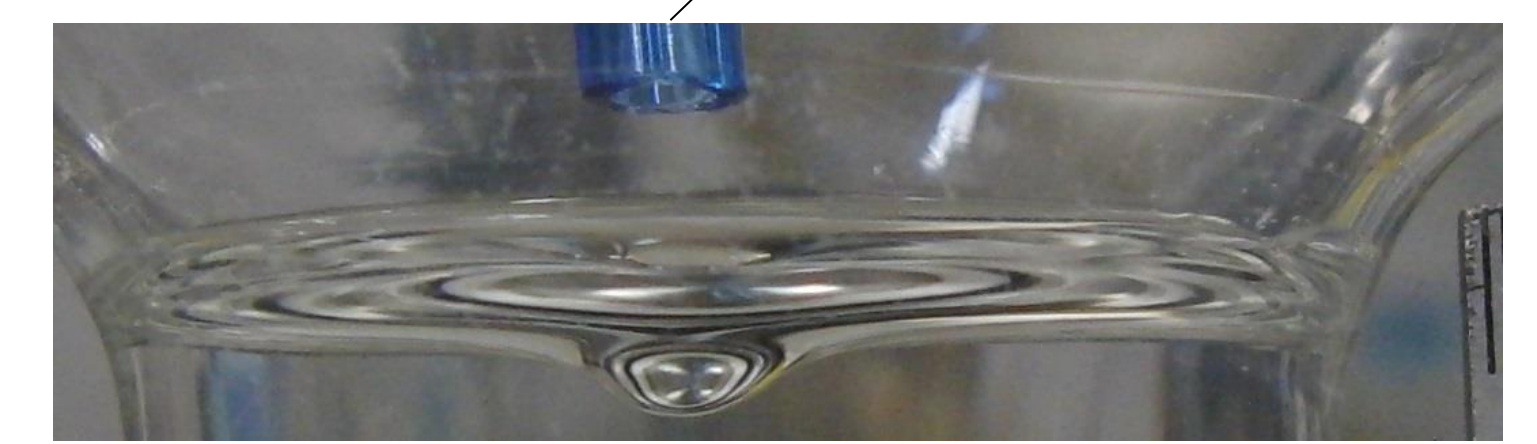

Mixing rate of water with corona

Mixing rate of water with gas injection

Simulation of flow induced by corona

Needle

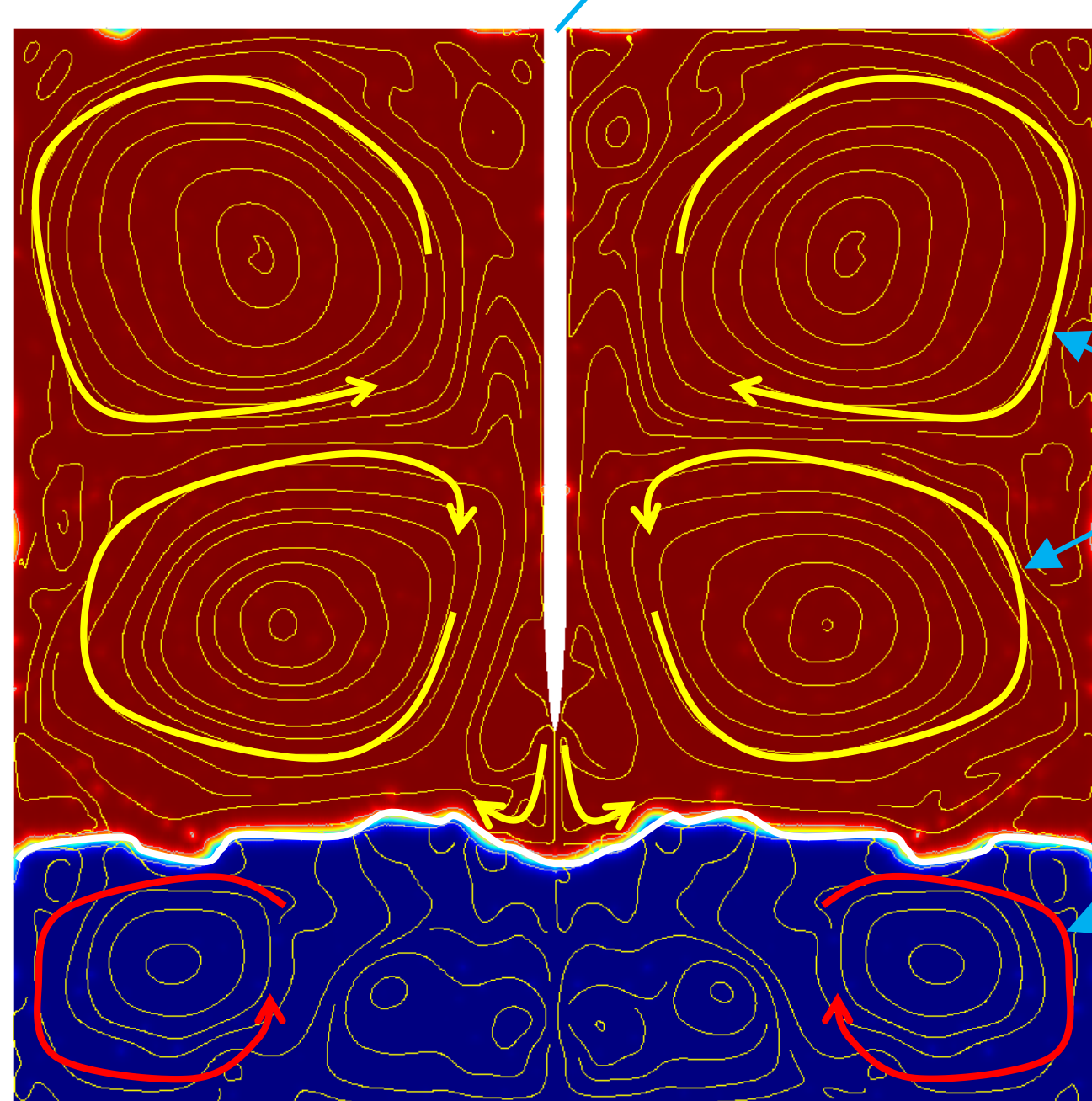

Circulating flow in gas (5 m/s)

Water surface

Circulating flow in water (5 cm/s)

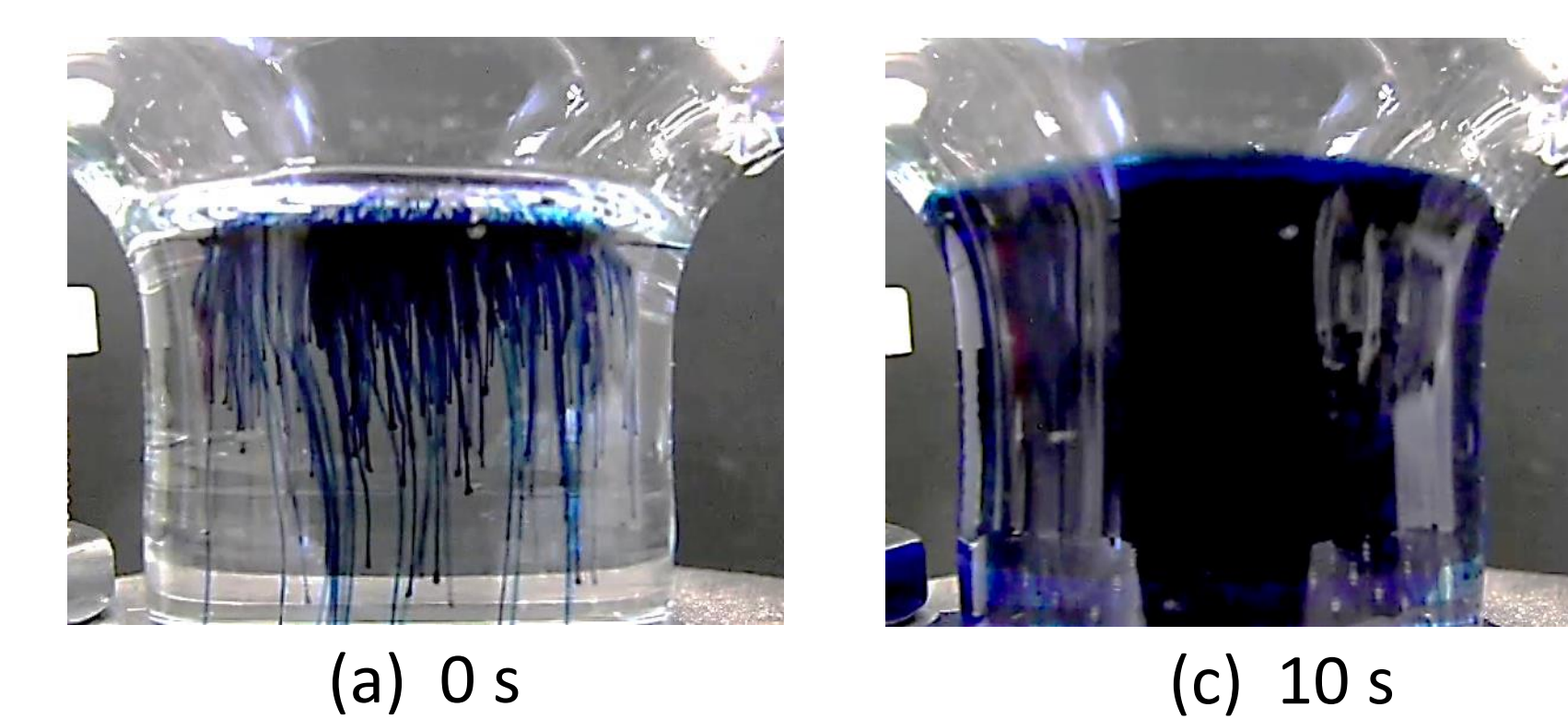

- Not only gas-phase flow but also liquid-phase flow was induced.
- Water was well mixed with corona discharge.

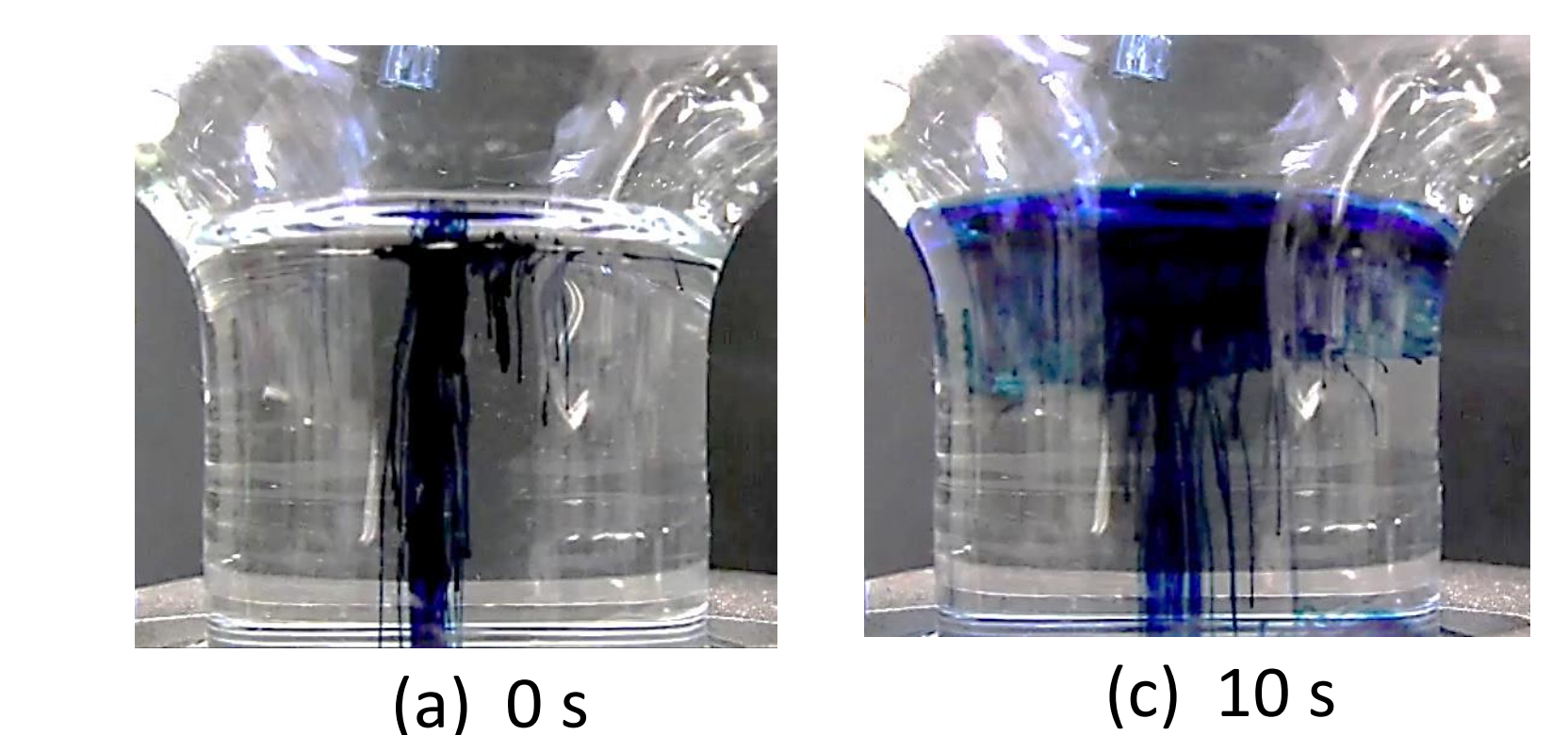

- Liquid-phase flow was induced with gas injection.
- Mixing of water was weaker than that with corona discharge.

Enhancement of Mass Transfer of Ozone

Time variation of MB concentration

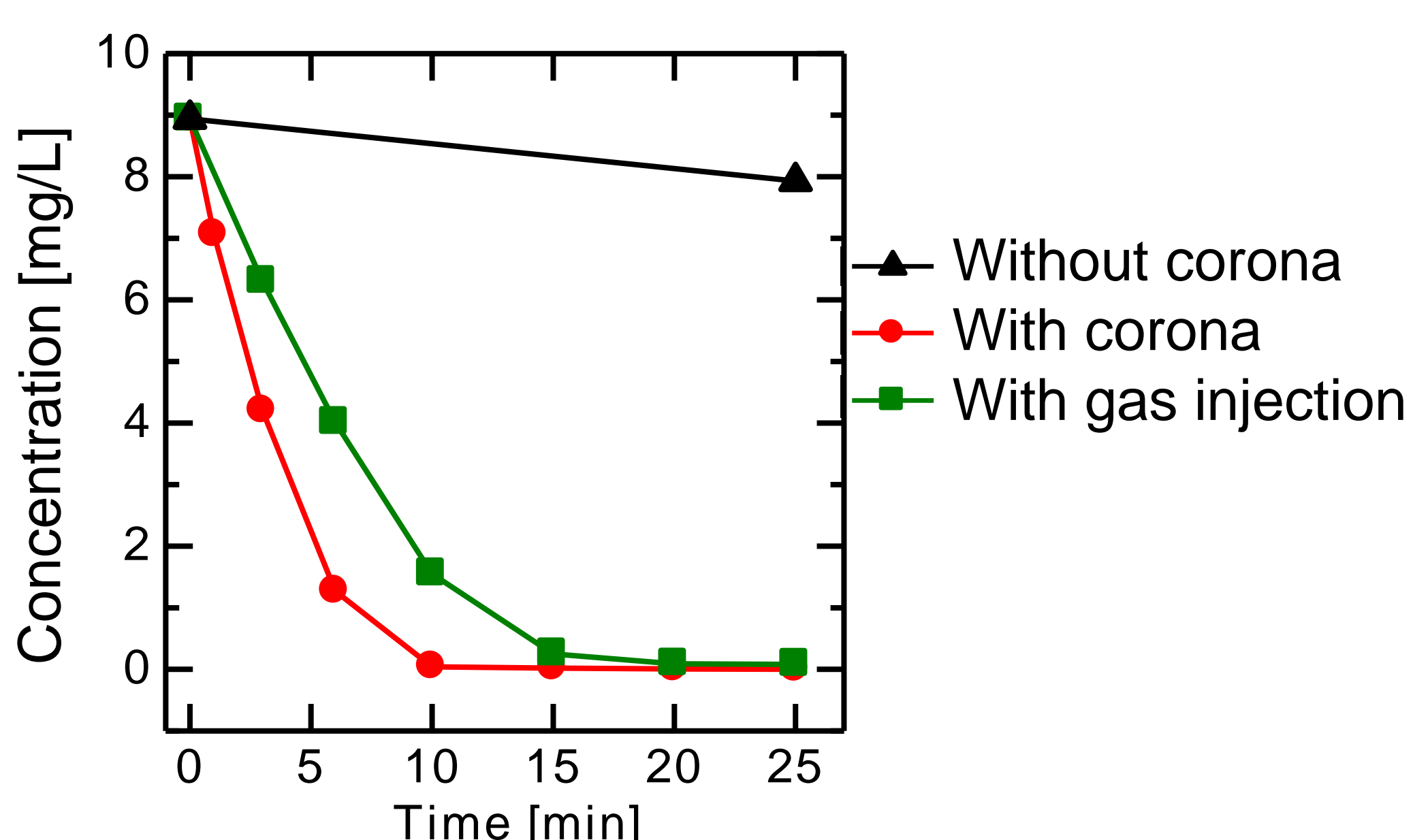

- The amount of ozone transferred to solution was evaluated from the amount of decomposed MB.

Mass transfer coefficient

Condition	Mass transfer coefficient: βk_c [cm/s]
Without corona	8.5×10^{-5}
With corona	3.9×10^{-3}
Gas injection	1.8×10^{-3}

$$\frac{dC_{aq}}{dt} = \beta k_c \frac{S}{V_{aq}} C_{gas}$$

C_{aq} : Evaluated ozone concentration in solution

C_{gas} : Ozone concentration in supplied gas

S : Area of gas–liquid interface

V_{aq} : Solution volume

- Without flow the mass transfer coefficient of ozone was so small because of a slow diffusion of ozone and methylene blue in the solution.
- The mass transfer of ozone was effectively enhanced in the case with the corona discharge.
- The main factor of the enhancement seems to be generation of liquid-phase flow and mixing of the solution by the flow.